

ENCORE™/ST G4

Processor Upgrade Card for Power Mac® G4 AGP Graphics

Quick Start Guide for Encore/ST G4

Power Mac and Operating System Compatibility

This Encore/ST G4 processor upgrade card is compatible only with Power Mac® G4 AGP Graphics, Gigabit Ethernet, Digital Audio, QuickSilver 2001, and single processor (800 and 933 MHz) QuickSilver 2002 models. *Installation of certain versions of this product into a Power Mac G4 Cube is also supported, and requires a Cube Installation Kit (sold separately); professional installation is strongly recommended. If you are unsure which Power Mac model you have, refer to the online Apple article that describes the differences at <http://docs.info.apple.com/article.html?artnum=58418>. This article lists model numbers, and describes physical aspects of the various Power Mac G4 models.*

At this printing, the Encore/ST G4 processor upgrade is compatible with Mac OS 9.2.1 through OS X version 10.3.x. For up-to-date Mac OS compatibility information, check our web site.



WARNING: In order for the Encore/ST G4 to operate in your system, Mac OS 9.2.1 (or later), and the latest Power Mac G4 firmware must be installed. If your system does not meet these criteria, you must upgrade to OS 9.2.1 (or later) and update your system's firmware before installing this upgrade. Otherwise, your system will not operate with the Encore/ST installed. Instructions follow.

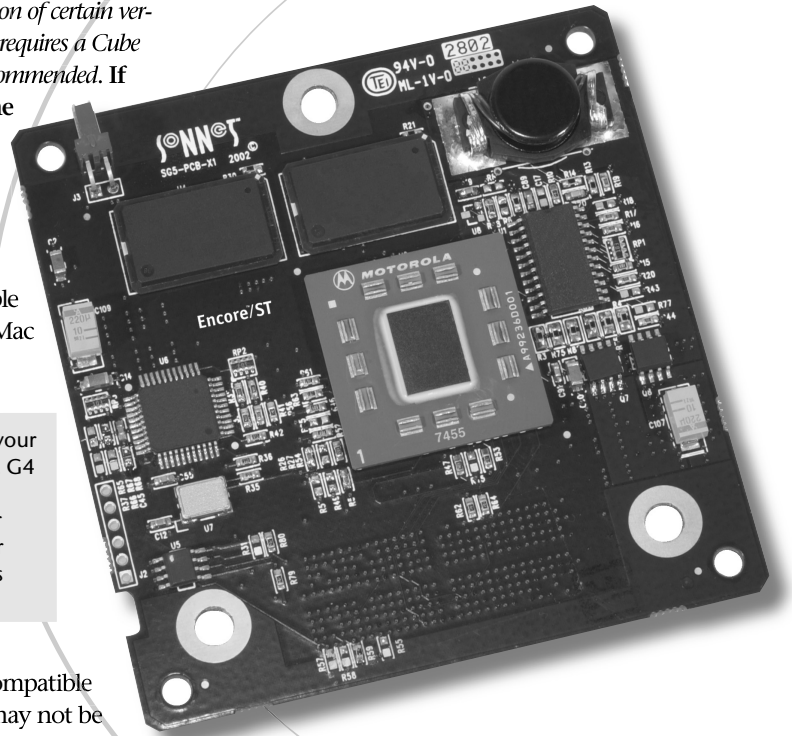

The Encore/ST G4 supports hard disk and display sleep in all compatible Power Mac G4 computers; in some configurations, deep sleep may not be supported.

You Should Have

The following items should be included in your product package:

- Encore/ST G4 processor upgrade card
- Processor card extension plate*
- Two extension plate mounting screws* (screwed into extension plate)

* Only required for installation of the Encore/ST in Gigabit Ethernet and Digital Audio models originally shipped with dual processors.

The following items are required for installation:

- Medium Phillips screwdriver
- Flat blade screwdriver
- Needle-nose pliers



Support Notes: Please familiarize yourself with the following instructions before beginning the installation. If you feel you are unable to install the computer hardware, please contact a qualified computer technician. Sonnet strongly recommends that a qualified technician perform this installation.

Before proceeding with the installation, we recommend that you make a backup of important information on your hard drive prior to installing new hardware or software.



SIMPLY FAST™

www.sonnettech.com

Remember to register your product online at <http://registration.sonnettech.com> to be informed of future upgrades and product releases.

Software updates and links are available from the Sonnet web site at www.sonnettech.com. • Online support form available at <http://supportform.sonnettech.com>.

Sonnet Technologies Customer Service hours are Mon.-Fri., 7 a.m.-5 p.m. Pacific Time • Customer Service Phone: 1-949-472-2772 • E-mail: support@sonnettech.com

Sonnet Technologies, Inc., Irvine, California USA • Tel: 1-949-587-3500 Fax: 1-949-457-6350

©2002 Sonnet Technologies, Inc. Revised 2004. All rights reserved. Sonnet, the Sonnet logotype, Simply Fast, the Simply Fast logotype, and Encore are trademarks of Sonnet Technologies, Inc. Macintosh and Mac are trademarks of Apple Computer, Inc., registered in the United States and other countries. Other product names are trademarks of their respective owners. Product specifications subject to change without notice. Printed in the USA. QSG-SG4-E-C-042004

Software and Firmware Installation/Update Info

Multiple Upgrade Recommendation

If you intend to perform multiple hardware upgrades to your Power Mac, we recommend that you complete the installation of the Encore/ST first, and then install the remaining upgrades; *complete each upgrade and test it before proceeding to the next.*

Install or Upgrade to Mac OS 9.2.1 or Later, If Necessary

The Encore/ST G4 requires Mac OS 9.2.1 or later in order to operate in your system, and must be installed before you install the processor upgrade card.

1. Verify the Mac OS version on your system is at least Mac OS 9.2.1, and then install or upgrade the OS software if necessary (Figure 1).

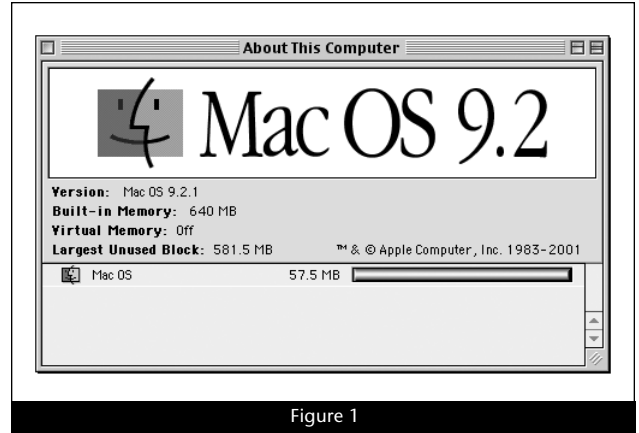

Figure 1

Update Power Mac Firmware

Before installing the Encore/ST, you must ensure your AGP Graphics, Gigabit Ethernet, or Digital Audio system's firmware has been updated to the latest version (currently 4.2.8). Please note, *your system must be able to make a connection to the Internet to perform some of the steps in this section.*

WARNING: When you install (or upgrade to) Mac OS 9.2.1 or later, you may have to upgrade the your computer's firmware as part of the software installation. Please note, the firmware installed with the Mac OS may not be the version required by the Encore/ST. **Before installing the Encore/ST, you may be required to upgrade your firmware again; you MUST ensure your system is using version 4.2.8 firmware.** If your system is using an earlier version of the firmware, your system will not operate with the Encore/ST installed.

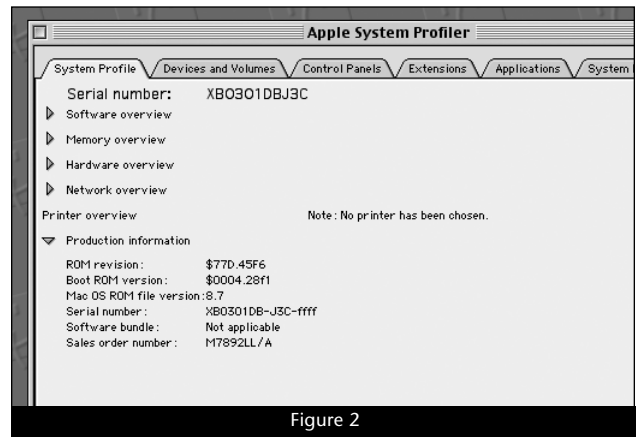

Figure 2

1. Boot your system in Mac OS 9.2.1 or later (not OS X, nor OS X Classic mode). As of this writing, Apple has not made this firmware updater available as an OS X application.
2. From the Apple Menu, select and open Apple System Profiler. Click the triangle next to Production Information, and find the Boot ROM version information (Figure 2). If it reads "\$0004.28f1", skip the rest of the steps in this section and proceed to page 3. Otherwise, go to step 3.
3. Log on to the Internet and type the following in your browser window's address bar:
<http://docs.info.apple.com/article.html?artnum=120068>.
4. Click on the appropriate link to download the firmware (Figure 3).
5. Double-click the G4 FW Update 4.2.8.smi file icon to mount the G4 Firmware Update disk image.
6. Double-click the G4 Firmware Update icon to open the disk image, then double-click the About G4 Firmware Update file icon. Once the read me file has opened, print it.
7. Following the directions on the pages you printed, update the firmware on your system. If a message appears stating that your firmware is up-to-date, proceed to the next section.

Language / OS Required	Release Date	Version	Read Me	Software
Any English Any English Mac OS 9.1 or later (but not X) is required	2001-10-18	4.2.8		 1.2 MB
Français French Mac OS 9.1 or later (but not X) is required	2001-10-25	4.2.8		 1.2 MB
Deutsch German Mac OS 9.1 or later (but not X) is required	2001-10-25	4.2.8		 1.2 MB
Español Spanish Mac OS 9.1 or later (but not X) is required	2001-10-25	4.2.8		 1.2 MB
Italiano Italian Mac OS 9.1 or later (but not X) is required	2001-10-25	4.2.8		 1.2 MB
Japanese Japanese Mac OS 9.1 or later (but not X) is required	2001-10-25	4.2.8		 1.2 MB

Figure 3

Installation—AGP Graphics and Gigabit Ethernet Models

This section covers the installation of the Encore/ST G4 into Power Mac AGP Graphics and Gigabit Ethernet models. If you are installing this product into a Digital Audio model, skip to page 7. If you are installing this product into a QuickSilver 2001 or QuickSilver 2002 model, skip to page 12.



WARNING: When handling computer products, take care to prevent components from being damaged by static electricity; avoid working in carpeted areas. Handle processor upgrade cards only by their edges and avoid touching connector traces and component pins.

Shut Down and Open Computer

1. Shut down your Power Mac. If the computer has been on, allow 20 minutes for it to completely cool before beginning the installation.
2. If you need to move the computer to a different area where you can work freely, disconnect any connected cables, move the computer, then reconnect the power cord.
3. Touch a port access cover on the back of the computer (**Figure 4**) to discharge any potentially damaging static electricity.
4. Disconnect the power cord from the computer.



Support Note: To avoid generating a static charge in your body, do not walk around the room until after you finish installing the Encore card and close the computer.

5. Locate the security lock at the back of the computer (**Figure 5**). If it is not already pressed in, do so now.
6. With the right side of the case facing you, open your Power Mac by lifting the release latch and lowering the side panel away from the computer's case (**Figure 6**).

Remove Heat Sink

Locate the processor heat sink on the logic board (**Figure 7**); your heat sink may appear different from what is pictured. Using caution to avoid touching the processor card, grasp one of the clips securing the heat sink with needle-nose pliers, between the heat sink and processor card. Pull down and away to unhook one side of the clip from the processor card (**Figure 6**). Push the clip away from you to unhook it from the other side. Repeat these steps with the other clip. Once the clips have been unhooked, gently lift the heat sink and clips away from the processor and set them aside, but not on the logic board.

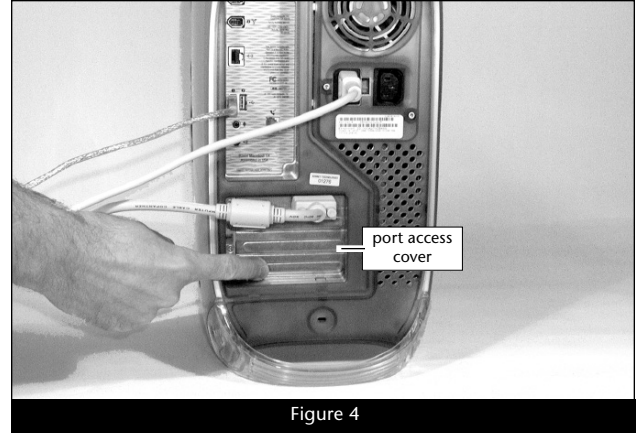

Figure 4



Figure 5

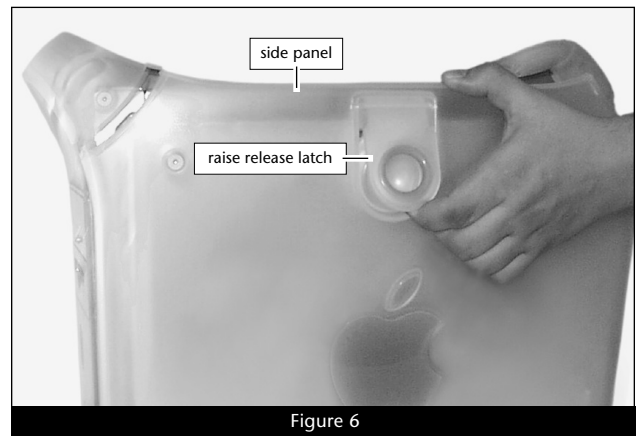

Figure 6

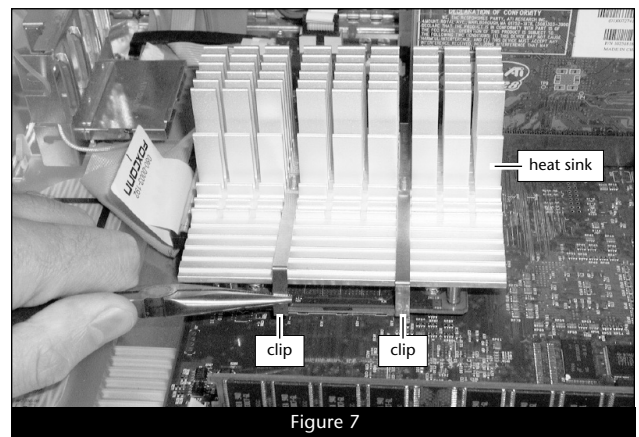
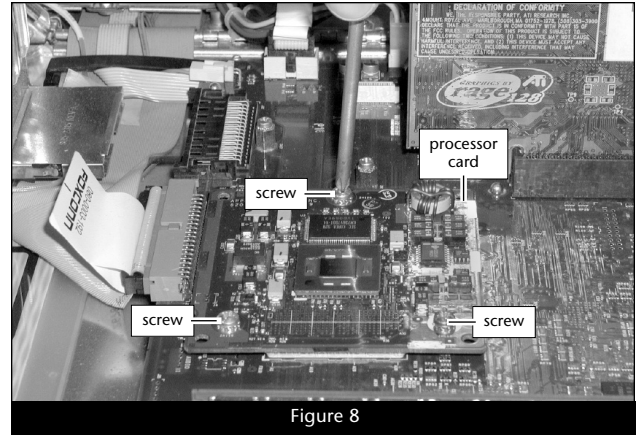

Figure 7

Installation—AGP Graphics and Gigabit Ethernet Models

Remove Processor Card

Remove the three screws securing the processor card to the logic board (Figure 8). Grasping the processor card by its edges, carefully lift it straight up and away from the logic board.



Support Note: You will find a piece of foam covering a connector on the edge of the Encore/ST card. Do not remove the foam; the connector is not used in this installation.

Install Encore/ST G4 Processor Upgrade Card

1. Remove the Encore/ST processor upgrade card from its anti-static package, and remove the packing material. Make sure to handle the card by the edges (Figure 9). Also, do not touch the thermal pad covering the processor.

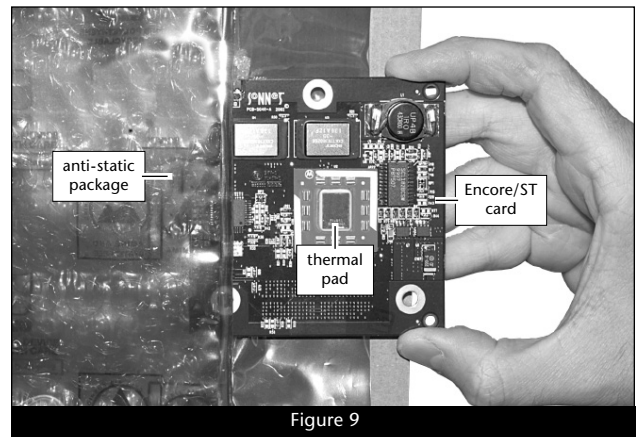

2. If you removed a single-processor card from your system, skip to step 3. If you removed a dual processor card, remove the extension plate and two screws from the parts bag included with the Encore/ST, and then remove the screws from the extension plate. With the Sonnet logo side of the board face up, place the Encore/ST processor card on top of the extension plate (support foot face down) as shown (Figure 10). Secure the Encore/ST card to the extension plate with the two provided screws; *do not overtighten the screws. Please note, when attached properly, the extension plate will be level with the Encore/ST board.*

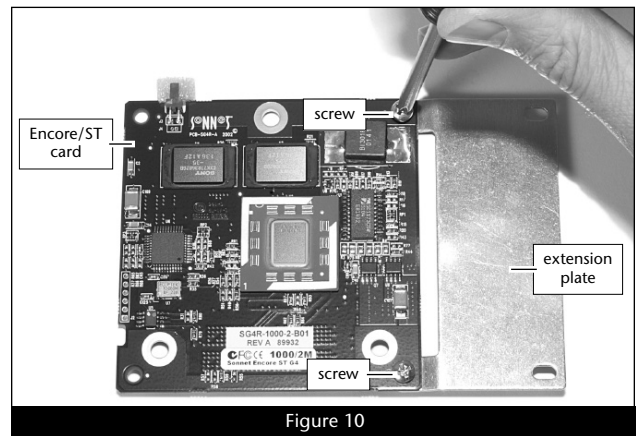

3. Hold the Encore/ST card with its connector facing up (Figure 11). Carefully remove the cap covering the connector; place the cap on the original processor card's connector. Place the processor card you removed from the computer into the anti-static package and store it in a safe place.

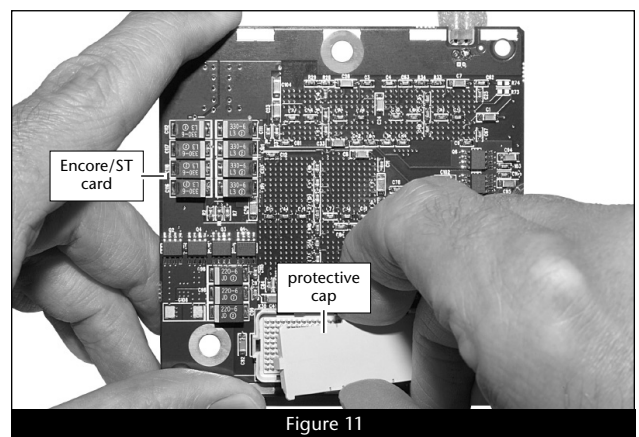

Installation—AGP Graphics and Gigabit Ethernet Models

- Align the Encore/ST card's three screw holes with the three threaded posts on the logic board, then set the card gently on top of the posts (**Figure 12**). Make sure the connectors are lined up, then, grasping the card by its edges, gently press it straight down until the connectors snap together. Verify the connectors are completely coupled by gently pulling up on the edges of the Encore/ST board; the board should remain firmly in place.

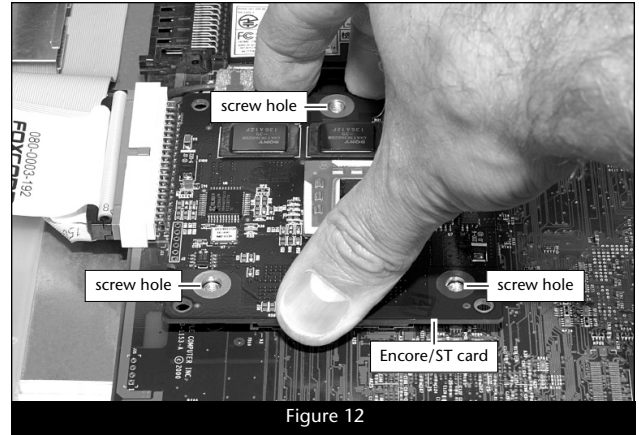

- Snugly secure the Encore/ST card to the logic board with the three screws you removed previously; **do not overtighten the screws** (**Figure 13**).

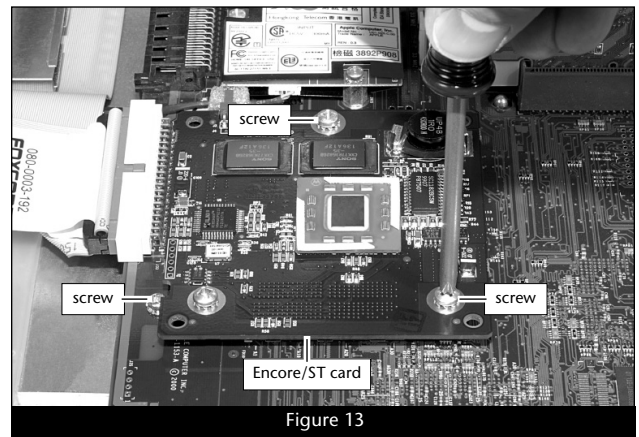

Reattach Heat Sink

Support Note: The following steps address the installation of your system's heat sink. Please note, only the single processor heat sink is pictured, but the procedure is identical for the dual processor heat sink. Please also note, that your heat sink may differ from what is pictured.

- The heat sink clips must be positioned properly on the heat sink. Examine the clips and note the short and long sections, and the dimple. When you reattach the heat sink, each clip will be placed on the heat sink so its long section rests in the tall fin area (**Figure 14**). Please note, this may be opposite of how the clips were originally installed.
- Set the clips aside. With the heat sink's tall fins at the back, guide the heat sink's posts into the holes on the Encore/ST card; place the clips across the heat sink, with the **long** sections resting in the tall fin area; make sure the clips do not get caught between the card and the heat sink (**Figure 15**). Verify that the heat sink is resting flat and level across the top of the Encore/ST card.

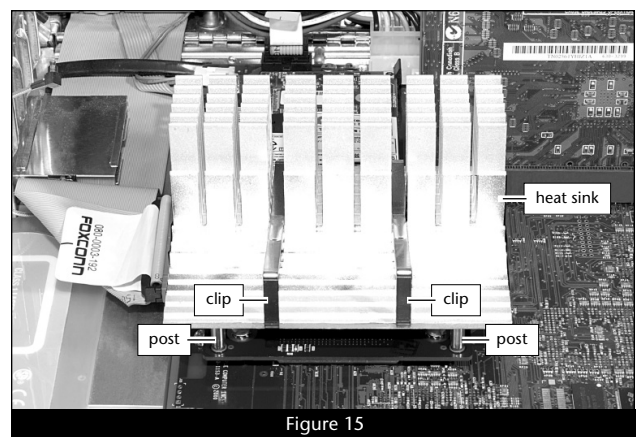
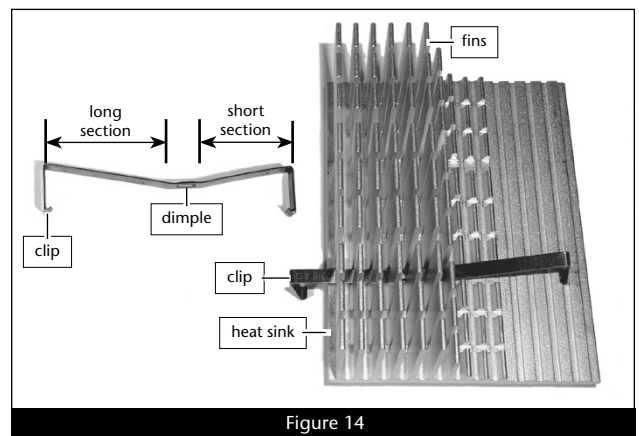

Installation—AGP Graphics and Gigabit Ethernet Models

3. Lift up a clip and hook it over the back edge of the Encore/ST card, then pull it toward you (Figure 16). Repeat this process with the other clip.

WARNING: The heat sink must be secured firmly, flatly and completely for reliable and stable operation. If the clips are not properly attached to the Encore/ST card at all four contact points, proper cooling of the processor will not occur and the processor will overheat, causing severe damage to the Encore/ST card. Repairs due to this damage are not covered by warranty.

4. Grasp a clip with needle-nose pliers, then pull it toward you and over the front edges of the heat sink and the Encore/ST card (Figure 17); be careful not to touch the Encore/ST card with the pliers, and be sure that the clip is grasping the card at both ends. Repeat this process with the other clip.
5. Visually inspect all four points where the clips attach to the Encore/ST card. It is easy for the clips to be attached only to the heat sink, which can lead to destructive overheating of your upgrade card. Verify that each clip is grasping the card at each end.

Support Note: Your Power Mac was designed to operate efficiently with the side panel closed. **Do not operate your computer with the side panel open;** proper air flow over the heat sink will not occur and the processor may overheat.

Close Computer

1. Raise the side panel back into place (Figure 18).
2. Return the computer to your computing area if necessary, and reconnect the power cord and peripheral cables to the computer.

Turn On Computer

Turn on your Power Mac; your accelerated machine should boot normally. Your installation is now complete.

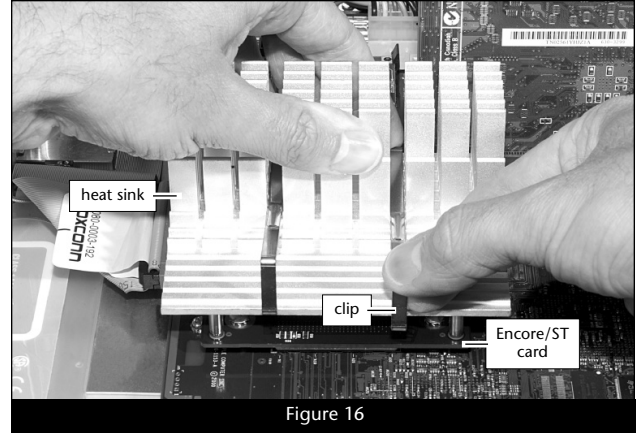

Figure 16

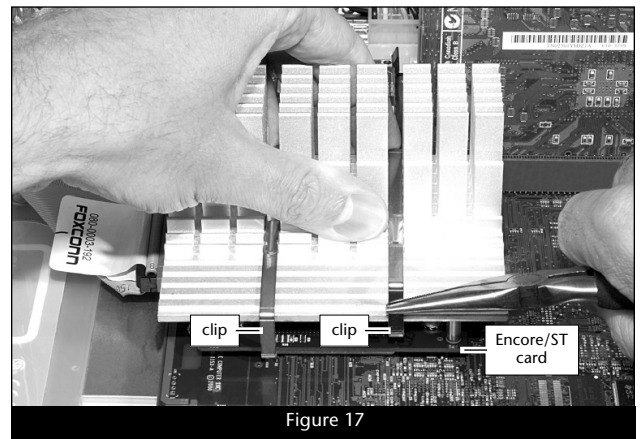

Figure 17

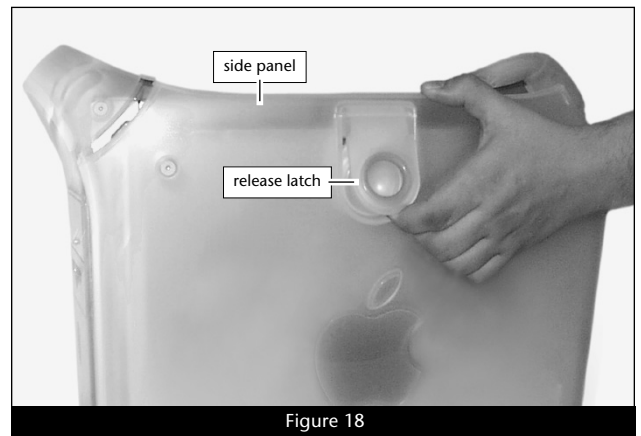

Figure 18

Installation—Digital Audio Models

This section covers the installation of the Encore/ST G4 into Power Mac G4 Digital Audio models (back panel appears like Figure 20). If you are installing this product into an AGP Graphics or Gigabit Ethernet model, go back to page 3. If you are installing this product into a QuickSilver 2001 or QuickSilver 2002 model, skip to page 12.



WARNING: When handling computer products, take care to prevent components from being damaged by static electricity; avoid working in carpeted areas. Handle processor upgrade cards only by their edges and avoid touching connector traces and component pins.

Shut Down and Open Computer

1. Shut down your Power Mac. If the computer has been on, allow 20 minutes for it to completely cool before beginning the installation.
2. If you need to move the computer to a different area where you can work freely, disconnect any connected cables, move the computer, then reconnect the power cord.
3. Touch a port access cover on the back of the computer to discharge any potential damaging static electricity (**Figure 19**).
4. Disconnect the power cord from the computer.



Support Note: To avoid generating a static charge in your body, do not walk around the room until after you finish installing the Encore card and close the computer.

5. If present, remove the two indicated screws from the back plate of the computer (**Figure 20**). Otherwise, go to step 6.
6. Locate the security lock at the back of the computer (**Figure 21**). If it is not already pressed in, do so now.
7. With the right side of the case facing you, open your Power Mac by lifting the release latch and lowering the side panel away from the computer's case (**Figure 22**).

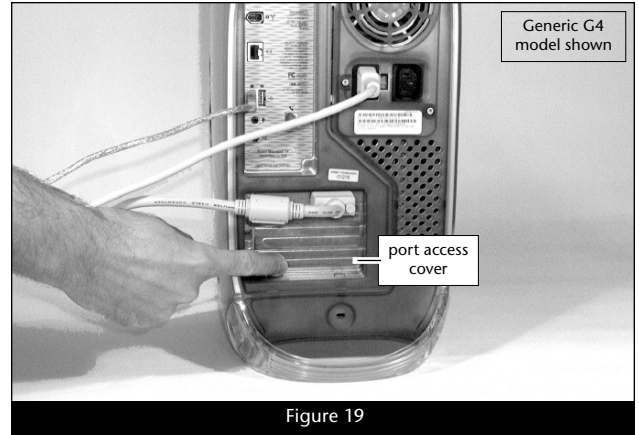

Figure 19

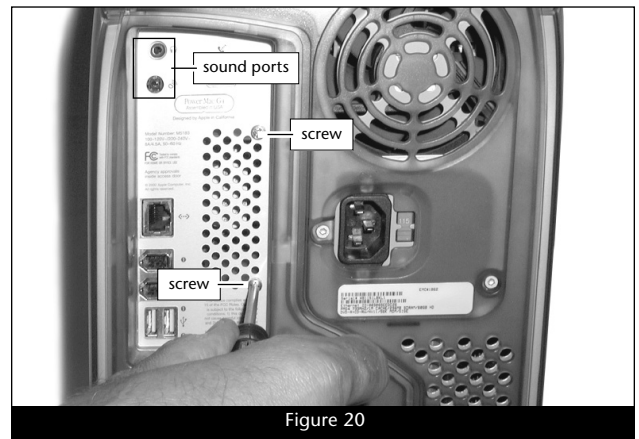

Figure 20

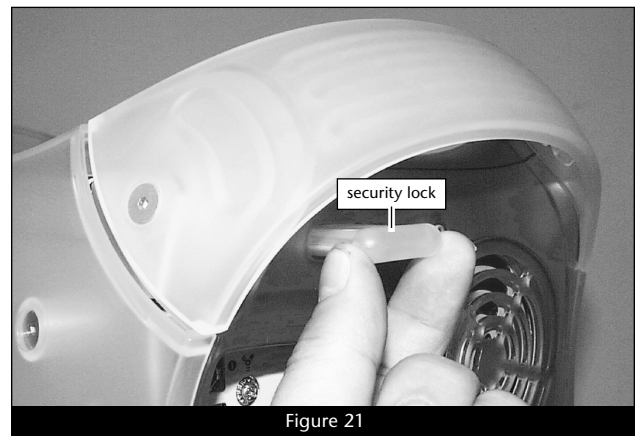

Figure 21

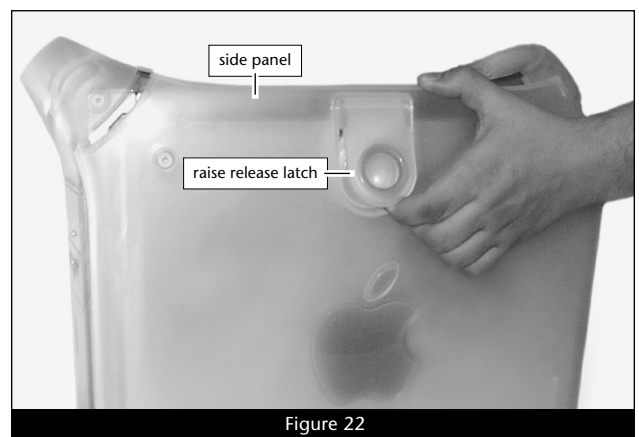

Figure 22

Installation—Digital Audio Models

Remove Fan Assembly

This section covers the removal of the fan assembly found on some Digital Audio models. If your machine does not have a fan assembly covering the processor heat sink, skip to “Remove Heat Sink” below.

1. Locate and carefully disconnect the 2-pin connector from the processor card (Figure 23).

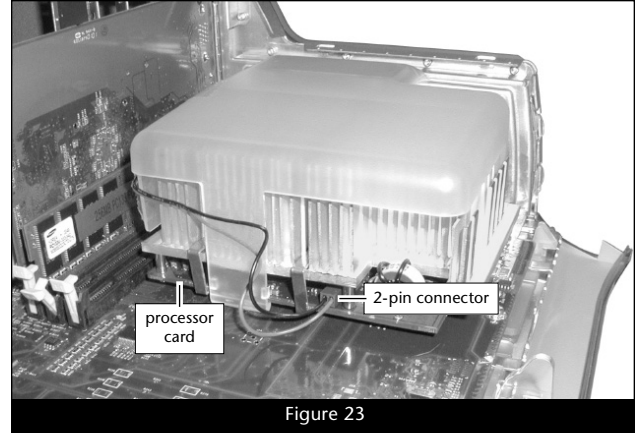

Figure 23

2. Unlatch the fan assembly's clips from the processor card and the heat sink, then lift the fan assembly out of the case and set it aside.

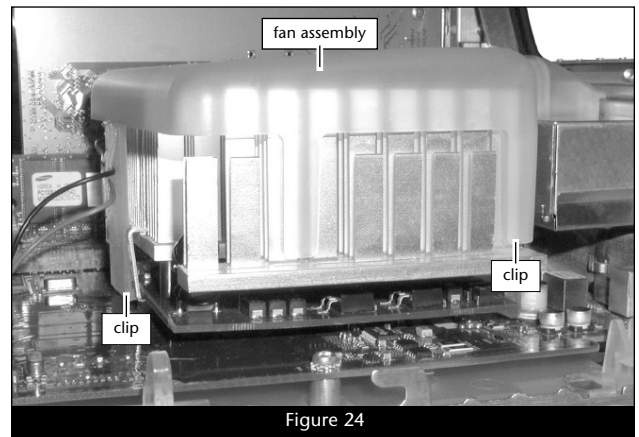

Figure 24

Remove Heat Sink

Locate the clips securing the processor heat sink to the processor card (Figure 25); your heat sink may appear different from what is pictured. Using caution to avoid touching the processor card, grasp one of the clips securing the heat sink with needle-nose pliers, between the heat sink and processor card. Pull down and away to unhook one side of the clip from the processor card (Figure 25). Push the clip away from you to unhook it from the other side. Repeat these steps with the other clip. Once the clips have been unhooked, gently lift the heat sink and clips away from the processor and set them aside, but not on the logic board.

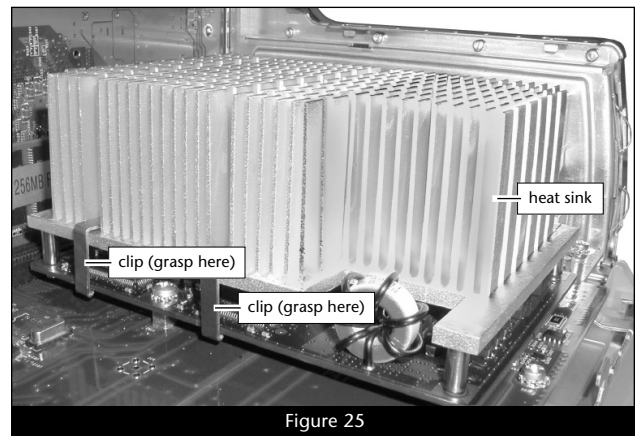

Figure 25

Remove Processor Card

Remove the three screws securing the processor card to the logic board (Figure 26). Grasping the processor card by its edges, carefully lift it straight up and away from the logic board.

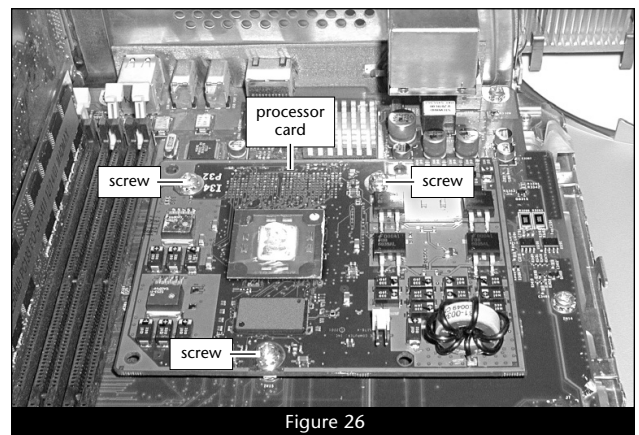

Figure 26

Installation—Digital Audio Models



Support Note: You will find a piece of foam covering a connector on the edge of the Encore/ST card. Do not remove the foam until instructed to do so.

Install Encore/ST G4 Processor Upgrade Card

1. Remove the Encore/ST processor upgrade card from its anti-static package, and remove the packing material. Make sure to handle the card by the edges (**Figure 27**). Also, do not touch the thermal pad covering the processor.

2. If you removed a single processor CPU card from your system, skip to step 3. If you removed a dual processor card, remove the extension plate and two screws from the parts bag included with the Encore/ST, and then remove the screws from the extension plate. With the Sonnet logo side of the board face up, place the Encore/ST processor card on top of the extension plate (support foot face down) as shown (**Figure 28**). Secure the Encore/ST card to the extension plate with the two provided screws; *do not overtighten the screws. Please note, when attached properly, the extension plate will be level with the Encore/ST board.*

3. Hold the Encore/ST card with its connector facing up (**Figure 29**). Carefully remove the cap covering the connector and place it on the original processor card's connector, then place the original processor card into the anti-static package and store it in a safe place.

4. Align the Encore/ST card's three screw holes with the three threaded posts on the logic board, then set the card gently on top of the posts (**Figure 30**). Make sure the connectors are lined up, then, grasping the card by its edges, gently press it straight down until the connectors snap together. Verify the connectors are completely coupled by gently pulling up on the edges of the Encore/ST board; the board should remain firmly in place.

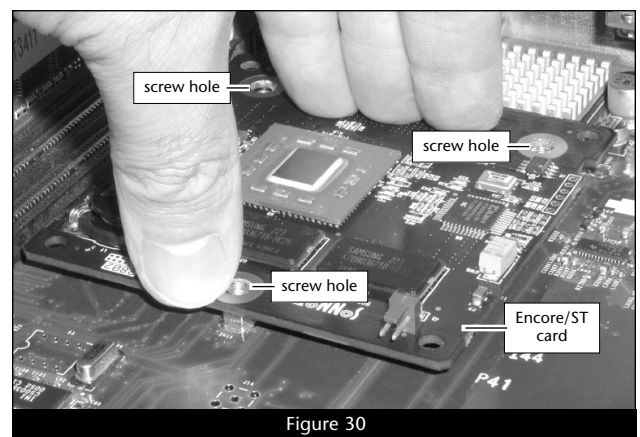
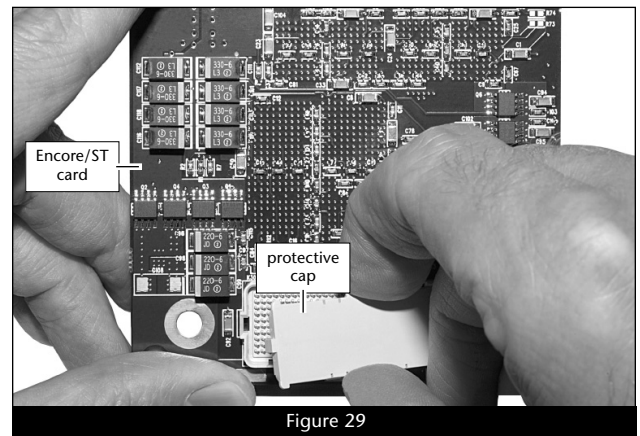
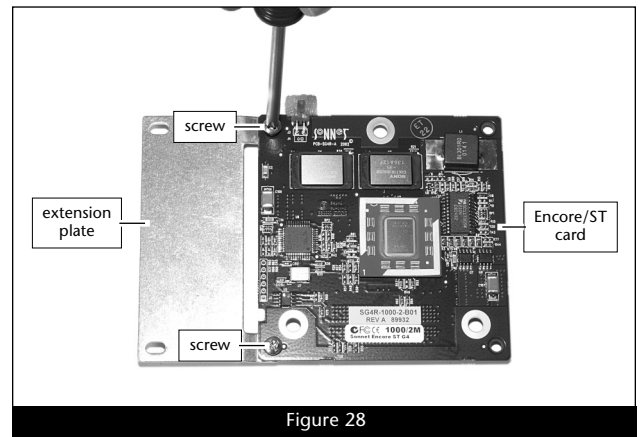
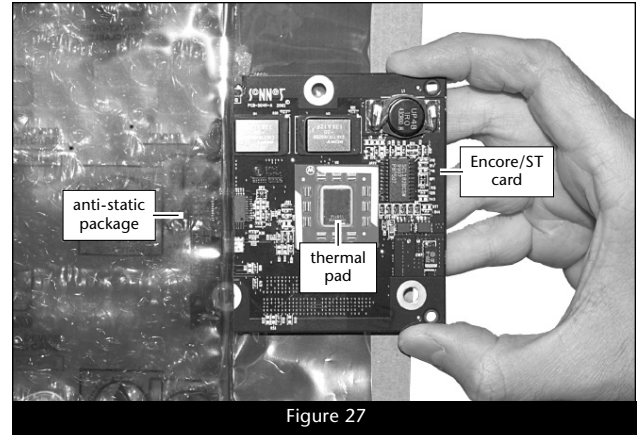

Installation—Digital Audio Models

5. Snugly secure the Encore/ST card to the logic board with the three screws you removed previously; *do not overtighten the screws* (Figure 31).

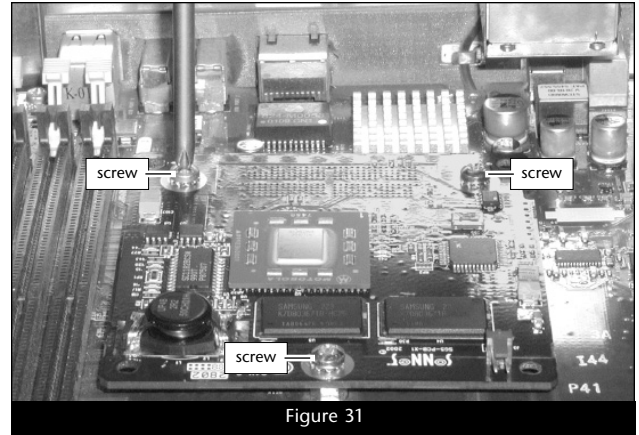

Figure 31

Reattach Heat Sink



Support Note: The following steps address the installation of your system's heat sink. Please note, only the single processor heat sink is pictured, but the procedure is identical for the dual processor heat sink. Please also note, that your heat sink may differ from what is pictured.

1. Position the heat sink clips properly on the heat sink (Figure 32). Examine the clips and note the short and long sections, and the dimple. Place each clip so its **short** section is closest to you (on the notched side of the heat sink). **Please note, this may be opposite of how the clips were originally installed.**
2. Grasping the heat sink with the notch facing you, guide the heat sink's posts into the holes on the Encore/ST card; make sure the clips do not get caught between the card and the heat sink (Figure 33). Verify that the heat sink is resting flat and level across the top of the Encore/ST card.
3. Lift up a clip and hook it over the back edge of the Encore/ST card, then pull it toward you. Repeat this process with the other clip. Grasp a clip with needle-nose pliers, then pull it toward you and over the front edges of the heat sink and the Encore/ST card (Figure 34); **be careful not to touch the Encore/ST card with the pliers, and be sure that the clip is grasping the card at both ends.** Repeat this process with the other clip.

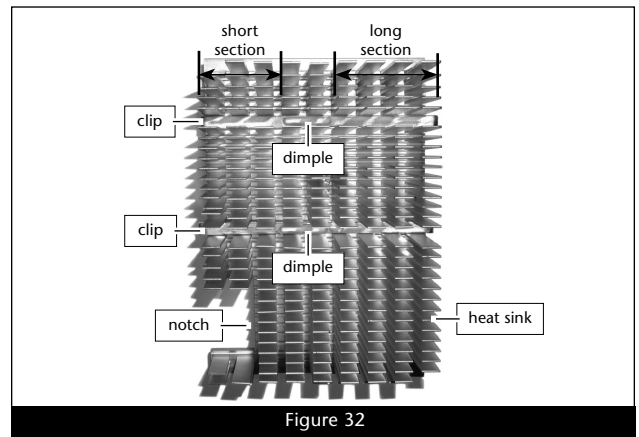

Figure 32

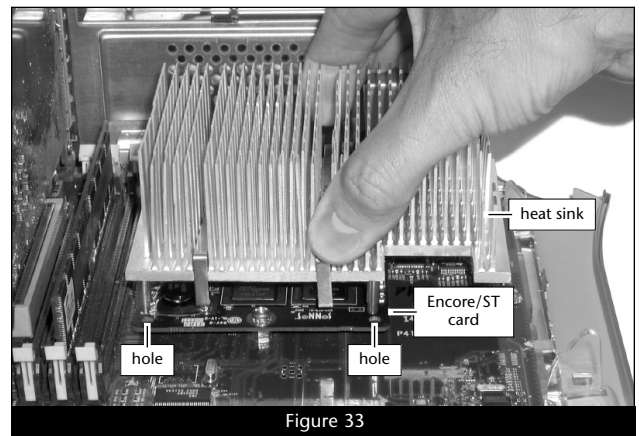

Figure 33



WARNING: The heat sink must be secured firmly, flatly and completely for reliable and stable operation. If the clips are not properly attached to the Encore/ST card at all four contact points, proper cooling of the processor will not occur and the processor will overheat, causing severe damage to the Encore/ST card. Repairs due to this damage are not covered by warranty.

4. Visually inspect all four points where the clips attach to the Encore/ST card. It is easy for the clips to be attached only to the heat sink, which can lead to destructive overheating of your upgrade card. Verify that each clip is grasping the card at each end.

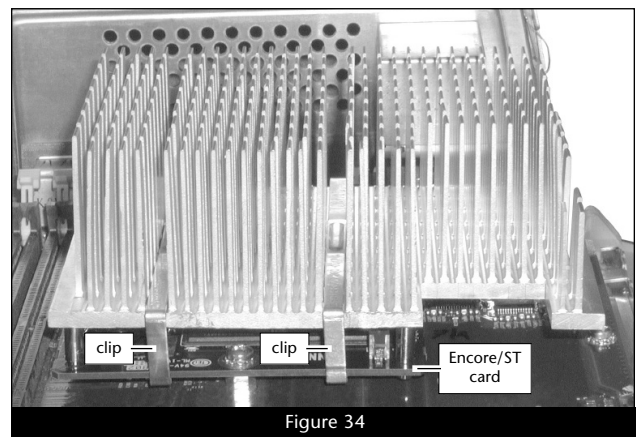

Figure 34

Installation—Digital Audio Models

Reinstall Fan Assembly and Close Computer



Support Note: The Encore/ST processor card operates reliably in Power Mac G4 Digital Audio models with or without a fan covering the heat sink. If your system does not have a fan assembly, leave the piece of foam covering the 2-pin connector on the edge of the Encore/ST card in place; skip steps 1 and 3 below.

1. Slide the fan assembly back over the heat sink, making sure the fan assembly's clips engage the Encore/ST card and the heat sink (Figure 35). Remove the foam covering the 2-pin connector on the edge of the Encore/ST card, and then carefully plug in the fan's 2-pin connector (Figure 35).

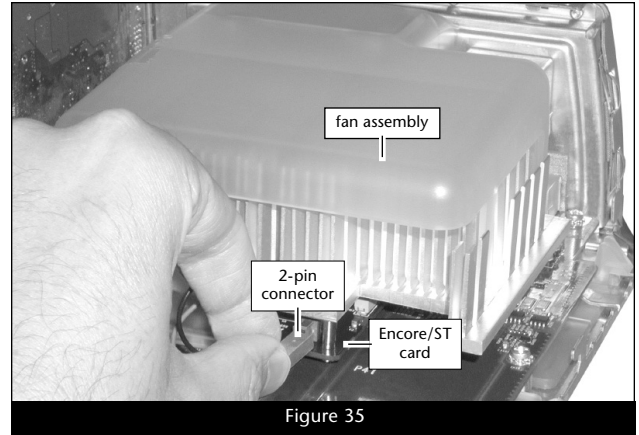

2. Raise the side panel back into place (Figure 36).

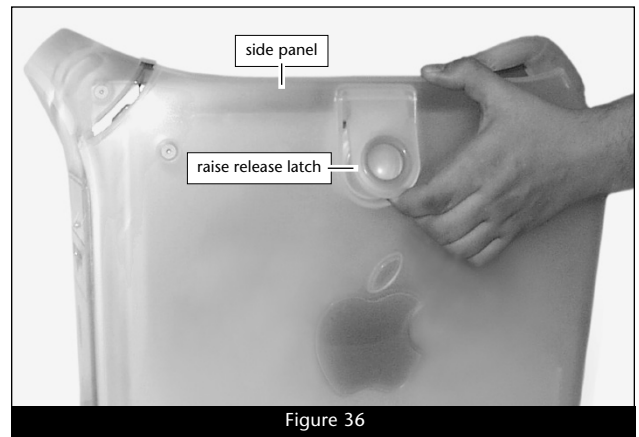

3. Using the two screws you removed previously, secure the fan assembly to the back plate of the computer (Figure 37).
4. Return the computer to your computing area if necessary, and reconnect the power cord and peripheral cables to the computer.

Turn On Computer

Turn on your Power Mac; your accelerated machine should boot normally. Your installation is now complete.



Installation—QuickSilver 2001 and 2002 Models



WARNING: The Encore/ST is not designed for installation into the Power Mac G4 (QuickSilver 2002) Dual 1GHz processor model. Do not attempt to install this product into that model.

This section covers the installation of the Encore/ST G4 into Power Mac G4 (QuickSilver 2001) and single processor (800 and 933 MHz) Power Mac G4 (QuickSilver 2002) models. If you are installing this product into an AGP Graphics or Gigabit Ethernet model, go back to page 3. If you are installing this product into a Digital Audio model, go back to page 7.



WARNING: When handling computer products, take care to prevent components from being damaged by static electricity; avoid working in carpeted areas. Handle processor upgrade cards only by their edges and avoid touching connector traces and component pins.

Shut Down and Open Computer

1. Shut down your Power Mac. If the computer has been on, allow 20 minutes for it to completely cool before beginning the installation.
2. If you need to move the computer to a different area where you can work freely, disconnect any connected cables, move the computer, then reconnect the power cord.
3. Touch a port access cover on the back of the computer to discharge any potential damaging static electricity (**Figure 38**).
4. Disconnect the power cord from the computer.



Support Note: To avoid generating a static charge in your body, do not walk around the room until after you finish installing the Encore card and close the computer.

5. Locate the security lock at the back of the computer (**Figure 39**). If it is not already pressed in, do so now.
6. With the right side of the case facing you, open your Power Mac by lifting the release latch and lowering the side panel away from the computer's case (**Figure 40**).

Remove Fan Assembly

1. With the back of the computer facing you, remove the two indicated screws (**Figure 41**).

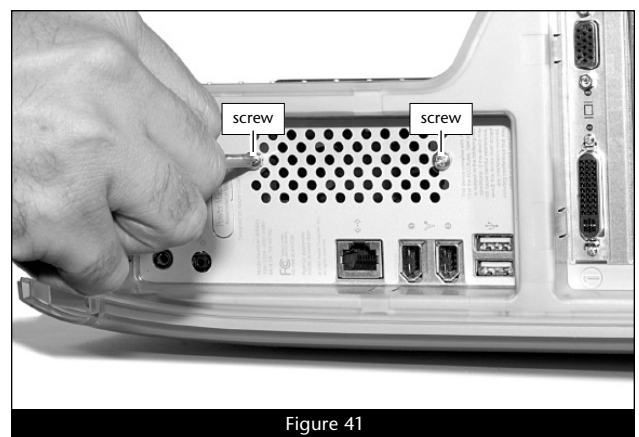
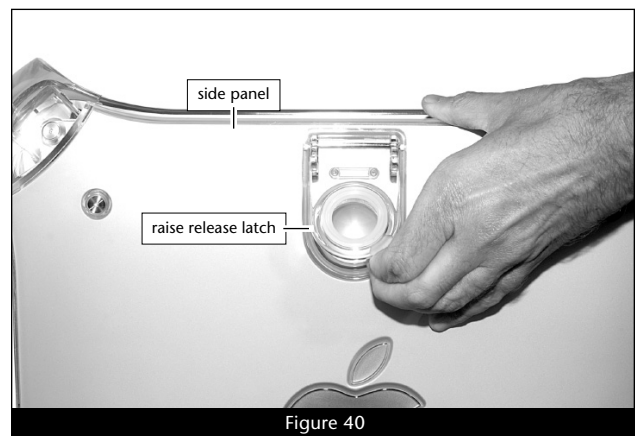
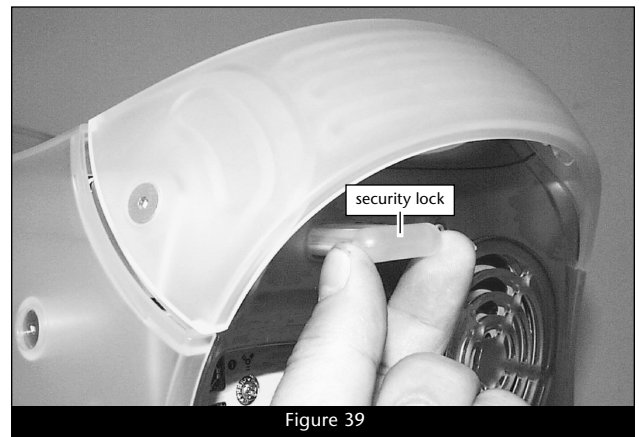
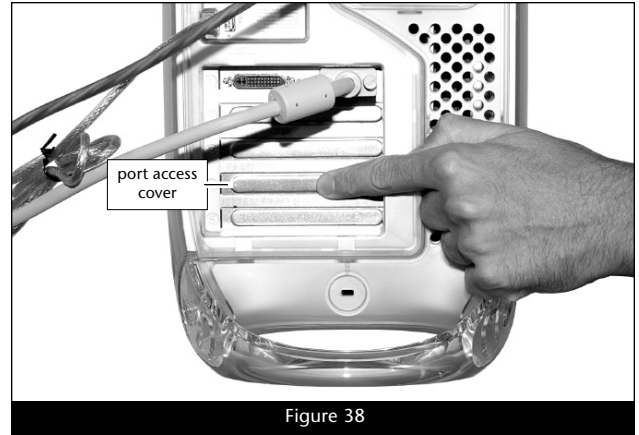

Installation—QuickSilver 2001 and 2002 Models

2. Locate and carefully disconnect the 2-pin fan power connector from the logic board, and then lift out the fan assembly (Figure 42).

 **Support Note:** The following steps address the removal of your system's processor card heat sink. Please note, the dual processor heat sink from a QuickSilver 2001 model is pictured, but the procedure to remove the single processor heat sink is identical.

 **WARNING:** Verify that the power cord is disconnected from your Power Mac before you remove the heat sink and processor card. The original processor card is secured to the logic board with four screws, one of which carries +12V and could spark if it is grounded when the system is on.

Remove Heat Sink

With the front of the computer facing you, locate the clips securing the heat sink to the processor card (Figure 43). Carefully insert a flat blade screwdriver between the right clip and the edge of the heat sink; **do not touch the edge of the processor card**. Using extreme caution, press down on the edge of the clip with needle-nose pliers, and twist the screwdriver to unhook one side of the clip from the processor card (Figure 43). Push the clip away from you to unhook it from the other side. Repeat these steps with the left clip. Once the clips have been unhooked, gently lift the heat sink and clips away from the processor card and set them aside, but not on the logic board.

Remove Processor Card

1. Remove the four screws securing the processor card to the logic board (Figure 44); set aside the indicated screw and do not reuse it.

2. Grasping the processor card by its edges, carefully lift it straight up and away from the logic board (Figure 45).

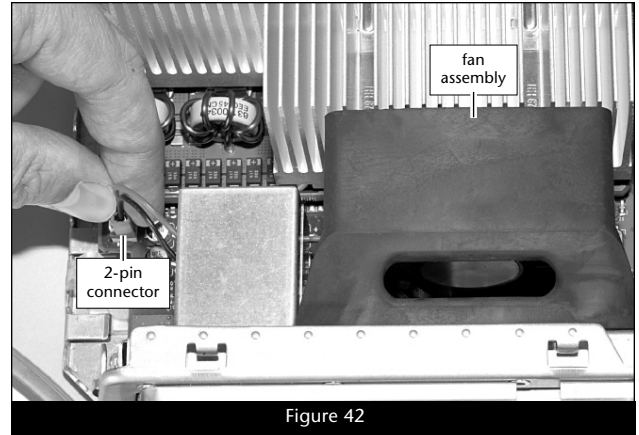

Figure 42

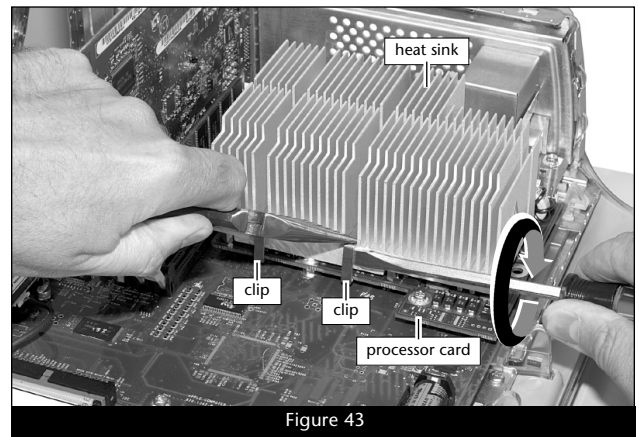

Figure 43

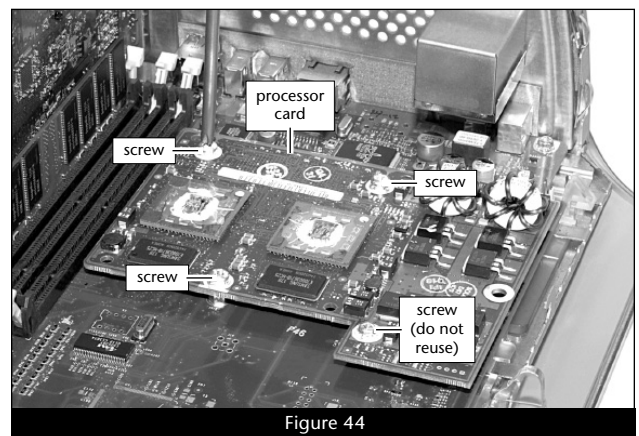

Figure 44

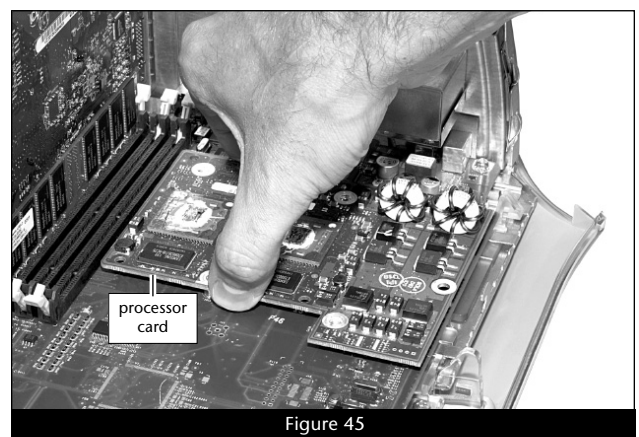

Figure 45

Installation—QuickSilver 2001 and 2002 Models

Install Encore/ST G4 Processor Upgrade Card



Support Note: You will find a piece of foam covering a connector on the edge of the Encore/ST card. Do not remove the foam; the connector is not used in this installation.

1. Remove the Encore processor upgrade card from its anti-static package, and remove the packing material. Make sure to handle the card by the edges (**Figure 46**). Also, do not touch the thermal pad covering the processor.

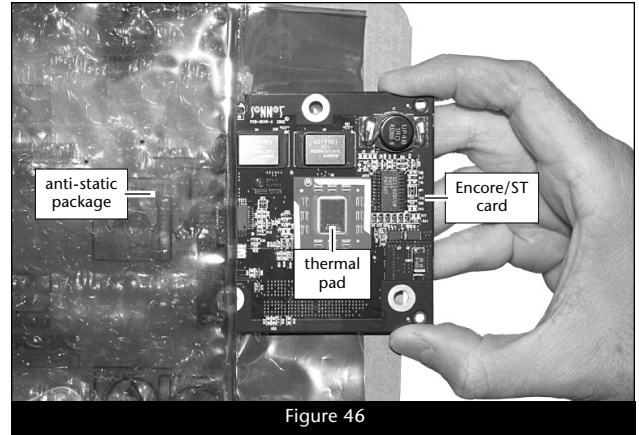

Figure 46

2. Hold the Encore/ST card with its connector face up (**Figure 47**). Carefully remove the cap covering the connector and place it on the original processor card's connector, then place the original processor card into the anti-static package and store it in a safe place.

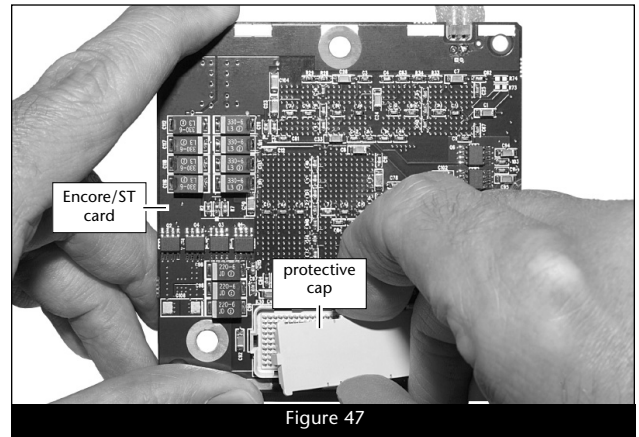

Figure 47

3. Align the Encore/ST card's three screw holes with the three threaded posts on the logic board, then set the card gently on top of the posts (**Figure 48**). Make sure the connectors are lined up, then, grasping the card by its edges, gently press it straight down until the connectors snap together. Verify the connectors are completely coupled by gently pulling up on the edges of the Encore/ST board; the board should remain firmly in place.

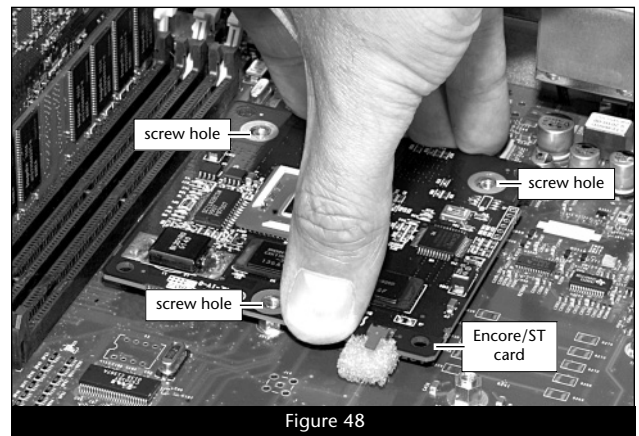

Figure 48

4. Snugly secure the Encore/ST card to the logic board with the three screws you removed previously; *do not overtighten the screws* (**Figure 49**).

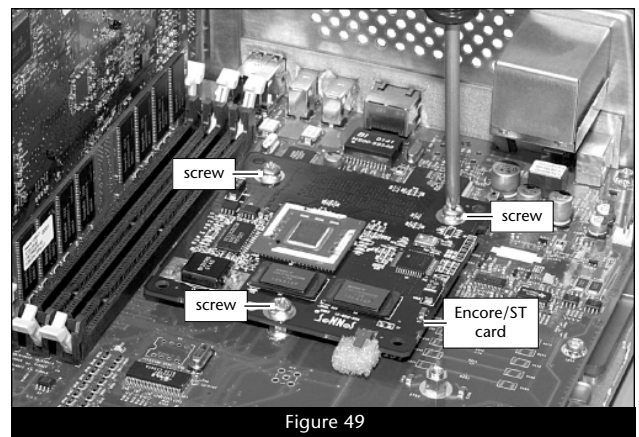

Figure 49

Installation—QuickSilver 2001 and 2002 Models

Reattach Heat Sink



Support Note: The following steps address the installation of your system's heat sink. Please note, only the single processor heat sink is pictured, but the procedure is similar for the dual processor heat sink. Please also note, that your heat sink may differ from what is pictured.

1. Make sure the heat sink clips are positioned properly on the heat sink (**Figure 50**); your heat sink may differ from what is pictured. Examine each clip and note the tab on the edge. Place each clip so its tab fits into the groove on the heat sink, and the clip drops to the bottom of the heat sink's fins.
2. Guide the heat sink's mounting posts into the holes on the Encore/ST card; make sure the clips do not get caught between the card and the heat sink (**Figure 51**). Verify that the heat sink is resting flat and level across the top of the Encore card.
3. Lift up a clip and hook it over the back edge of the Encore card, then pull it toward you. Repeat this process with the other clip. Carefully insert a flat blade screwdriver between the left clip and the edge of the processor card; **do not touch the edge of the processor card**. Using extreme caution, press down on the edge of the clip with needle-nose pliers, and twist the screwdriver to hook the clip over the edge of the Encore/ST card. **Be certain that the clip is grasping the card at both ends.** Repeat this process with the other clip (**Figure 52**).

WARNING: The heat sink must be secured firmly, flatly and completely for reliable and stable operation. If the clips are not properly attached to the Encore card at all four contact points, proper cooling of the processor will not occur and the processor will overheat, causing severe damage to the Encore card. Repairs due to this damage are not covered by warranty.

4. Visually inspect all four points where the clips attach to the Encore/ST card. It is easy for the clips to be attached only to the heat sink, which can lead to destructive overheating of your upgrade card. Verify that each clip is grasping the card at each end.

Reinstall Fan Assembly and Close Computer

1. While holding its 2-pin connector, place the fan assembly between the heat sink and the back panel of the computer, against the modem filter (**Figure 53**). Carefully plug in the fan's 2-pin connector to the connector on the logic board (**Figure 53**).

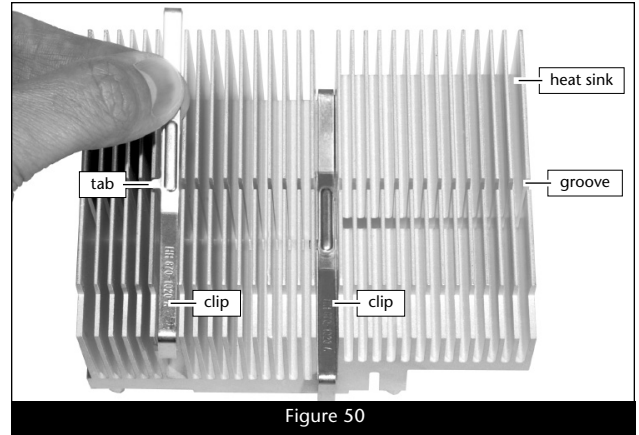

Figure 50

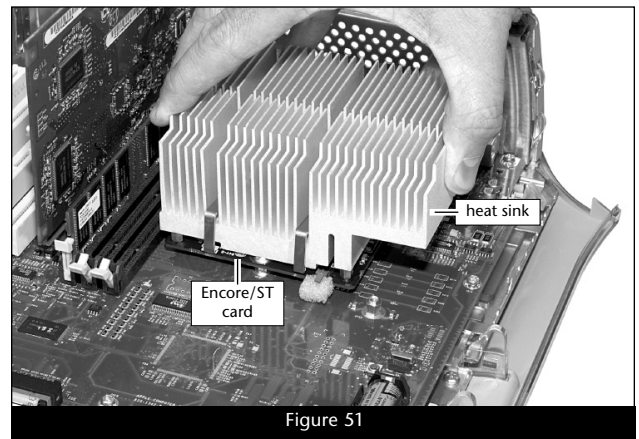

Figure 51

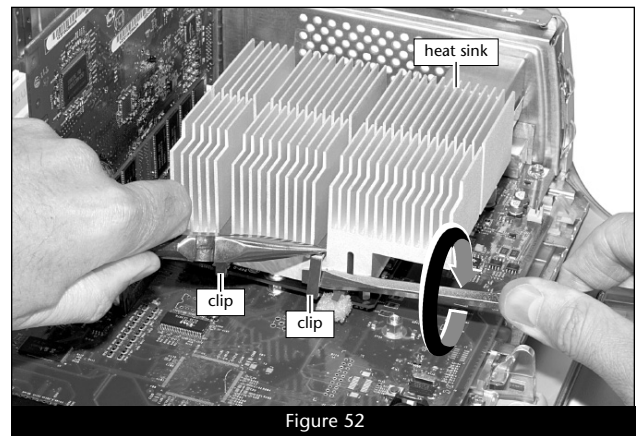

Figure 52

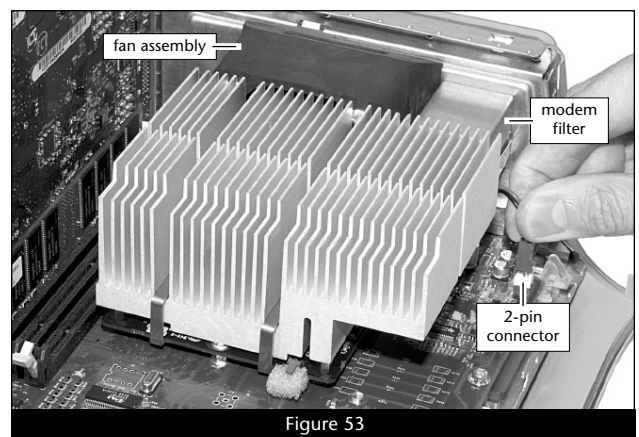

Figure 53

Installation—QuickSilver 2001 and 2002 Models

2. With the back of the computer facing you, secure the fan assembly to the back plate of the computer with the two screws you removed previously (Figure 54).

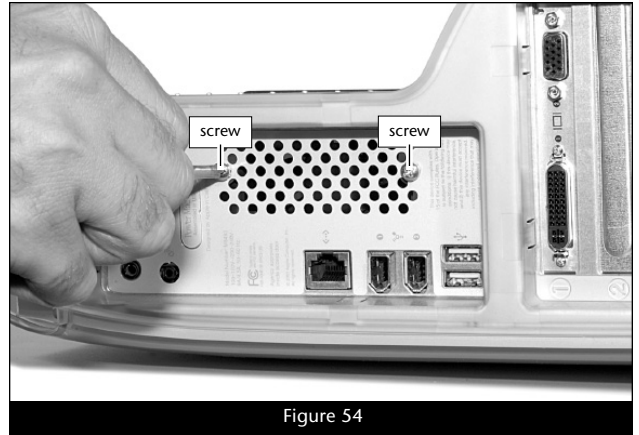

Figure 54

3. Raise the side panel back into place (Figure 55).
4. Return the computer to your computing area if necessary, and reconnect the power cord and peripheral cables to the computer.

Turn On Computer

Turn on your Power Mac; your accelerated machine should boot normally. Your installation is now complete.

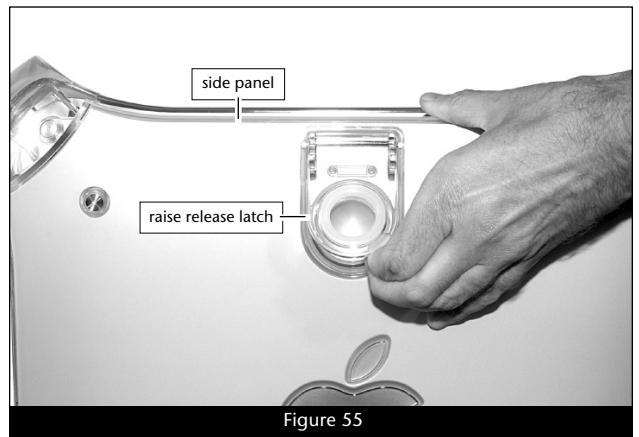

Figure 55